

# system DALLAS

D-7

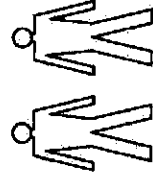

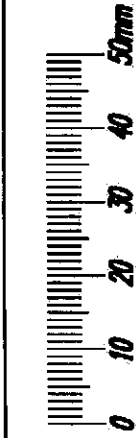



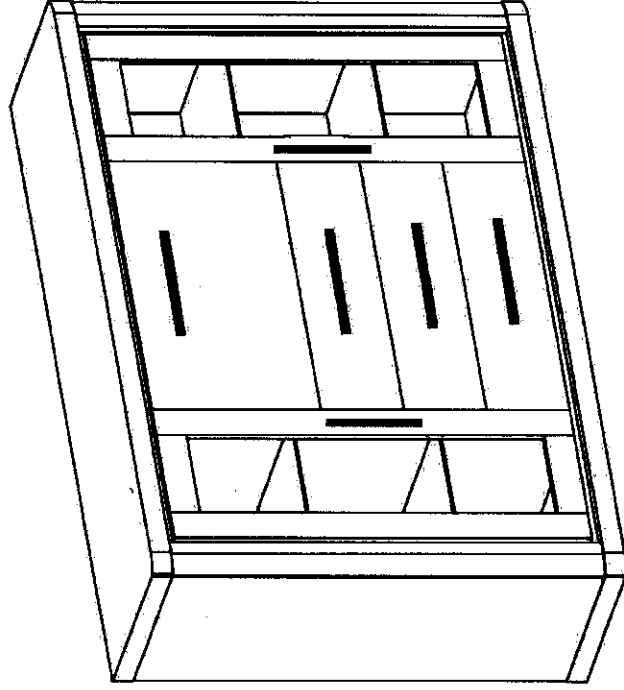
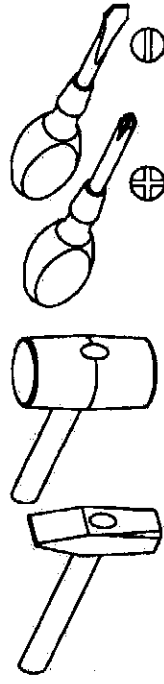







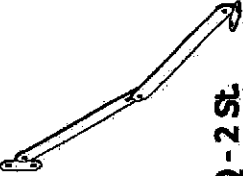



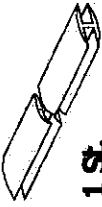

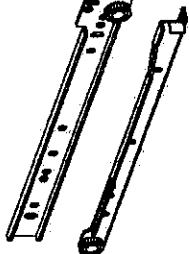

# INSTRUKCJA MONTAŻU

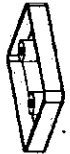
Narzędzia potrzebne do montażu



W przypadku reklamacji proszę o podanie numeru pakowacza znajdującego się na kartonie

 <b>W - 4 St.</b>	 <b>I - 2 St.</b>	 <b>Y - 12 St.</b>	 <b>F - 12 St.</b>	 <b>Q - 2 St.</b>
 <b>R - 12 St.</b> 3 x 30 mm	 <b>P - 16 St.</b>	 <b>M - 12 St.</b> 4 x 25 mm	 <b>H - 1 St.</b>	 <b>L - 22 St.</b>
 <b>T - 3 Kpl.</b>	 <b>N - 12 St.</b> 4 x 30 mm	 <b>U - 6 St.</b>	 <b>G - 20 St.</b> 3,5 x 16 mm	 <b>S - 1 St.</b>
 <b>A - 6 St.</b>	 <b>B - 28 St.</b>	 <b>C - 6 St.</b>	 <b>D - 4 St.</b>	 <b>J - 12 St.</b> 5 x 13 mm
		 <b>K - 22 St.</b>	 <b>Z - 1 St.</b>	

I

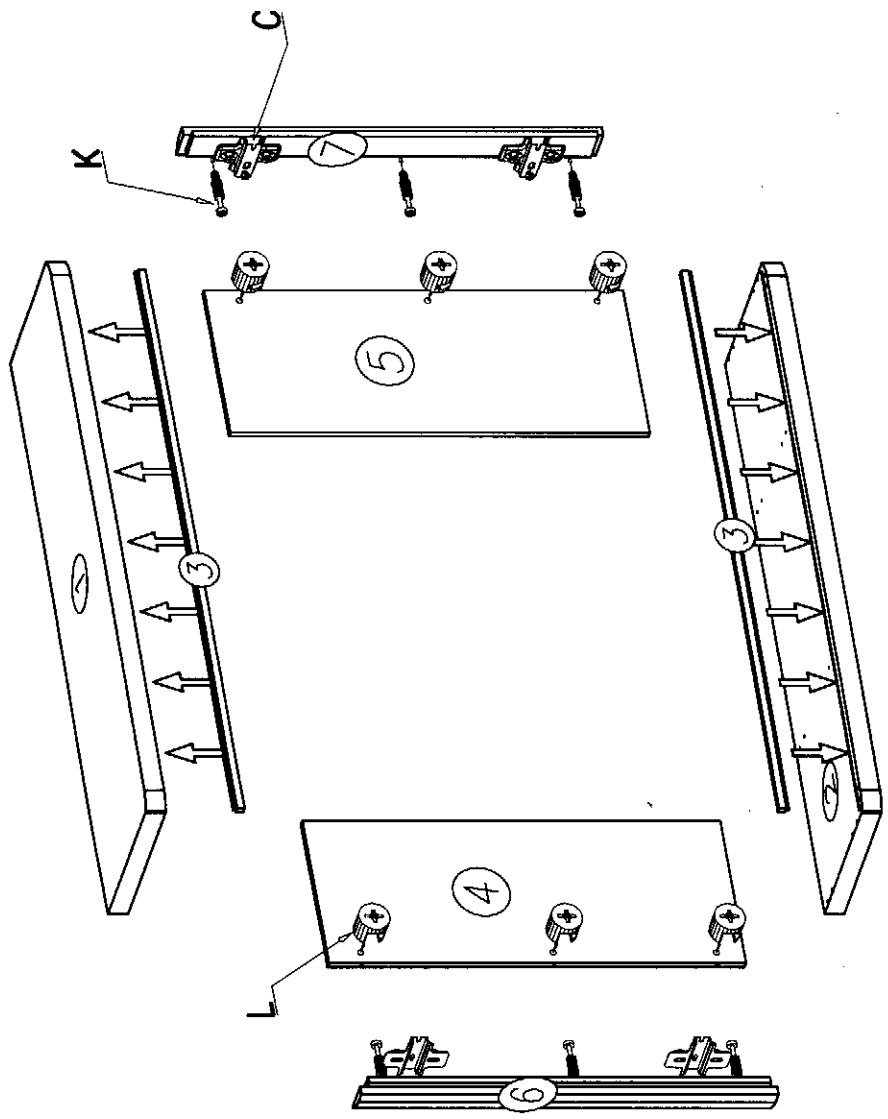

II

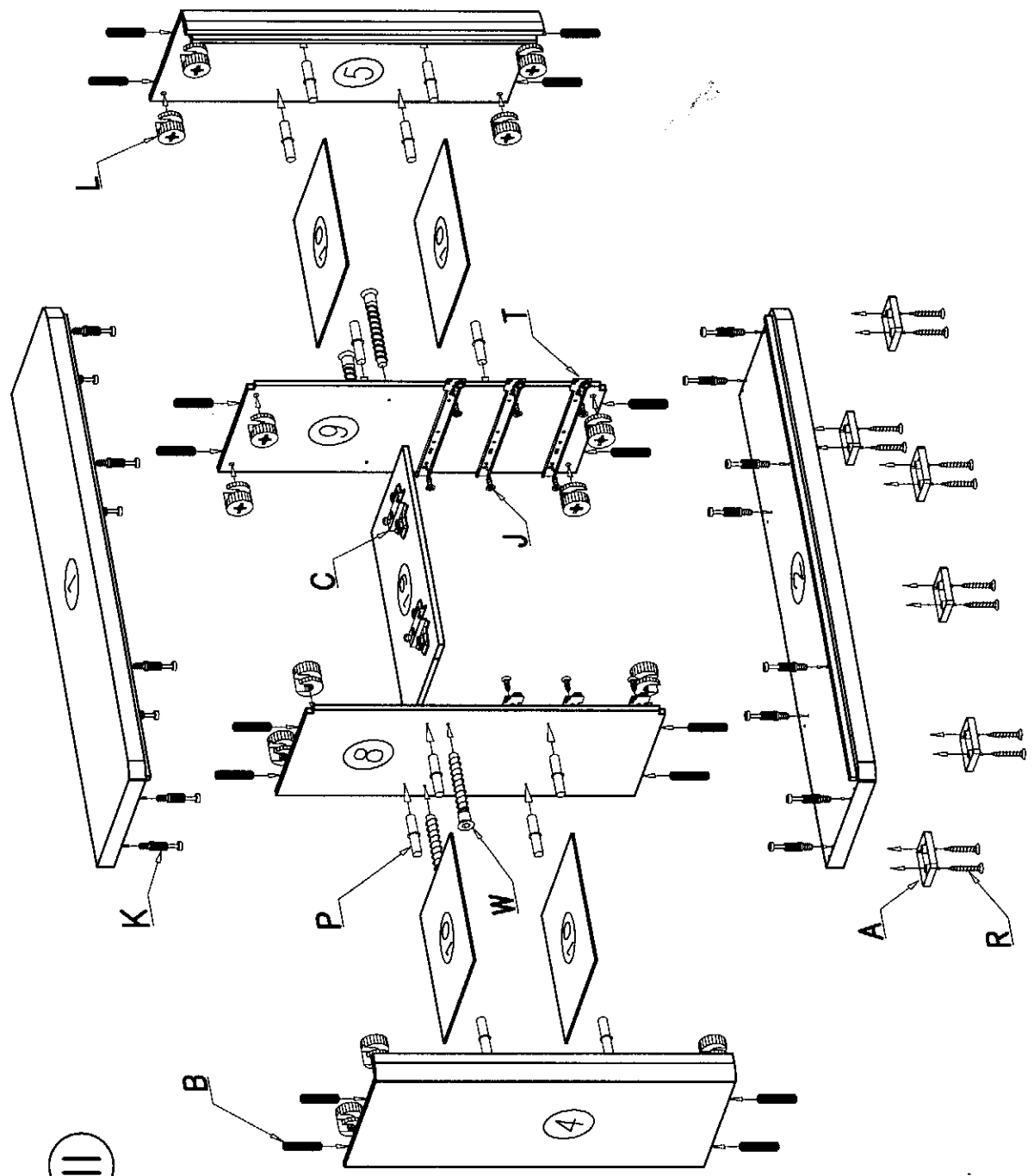

III

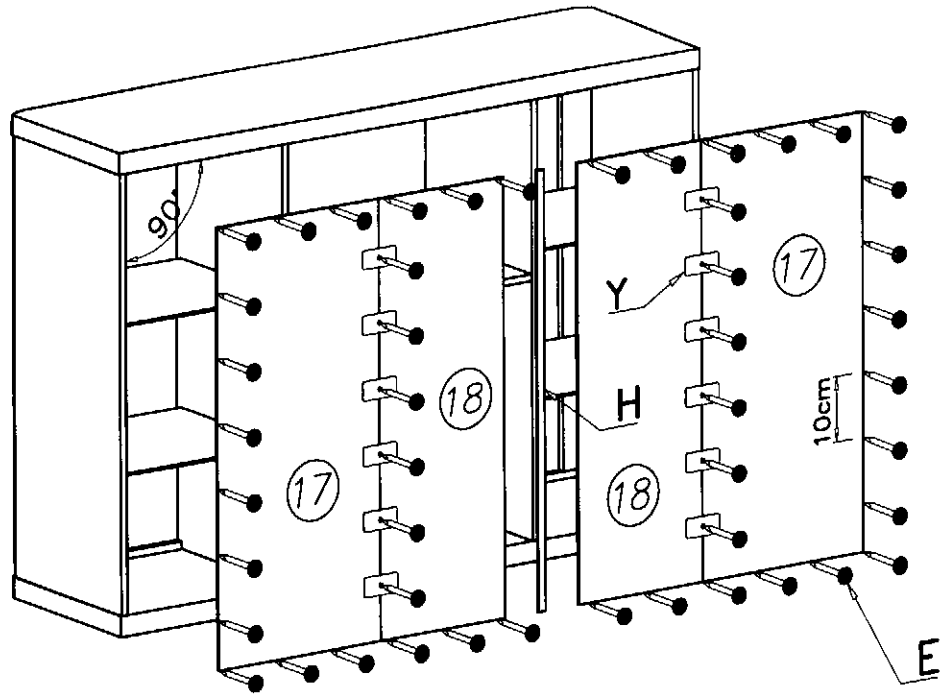

IV

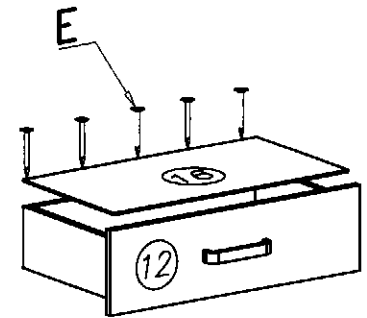
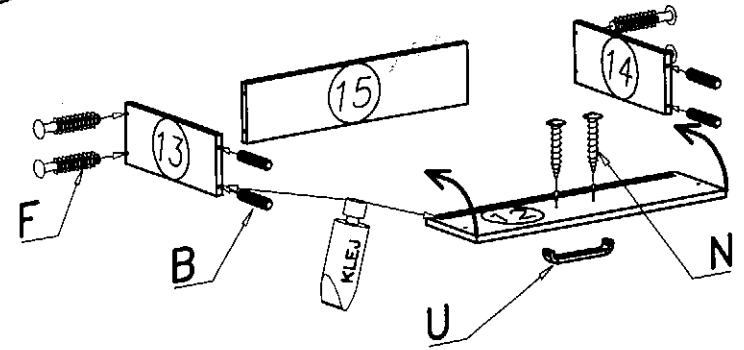

V

