

system DALLAS

D-19

INSTRUKCJA MONTAŻU

Narzędzia potrzebne do montażu

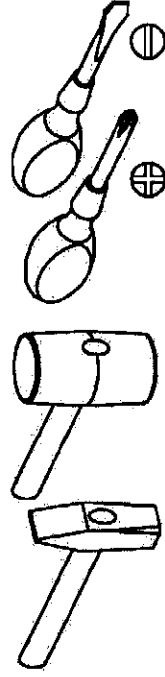
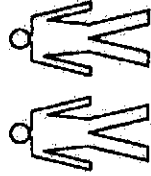
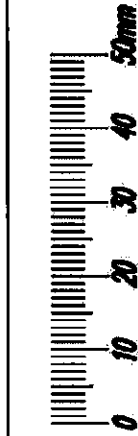

lewa

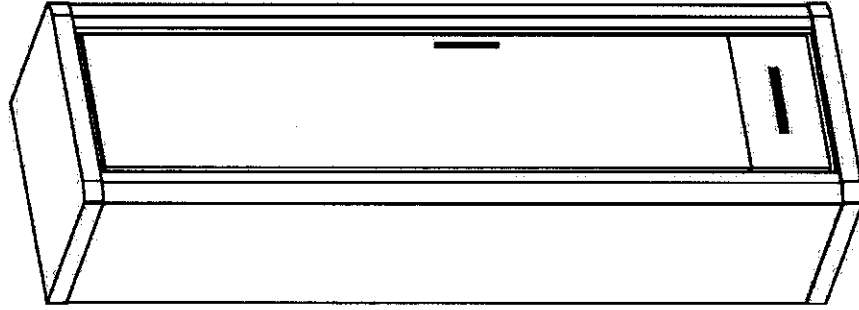





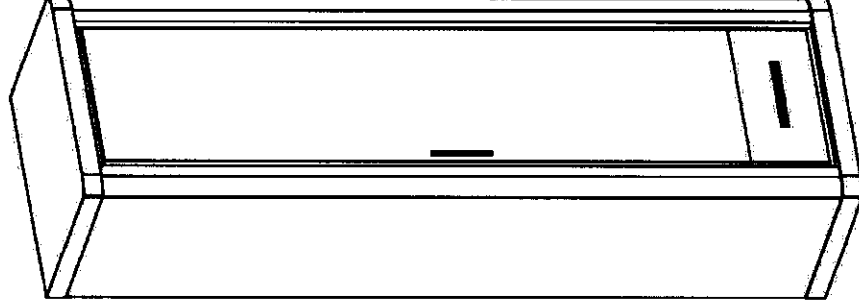















lub

prawa

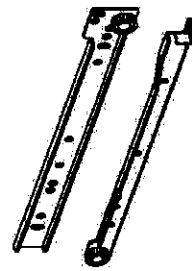

W przypadku reklamacji proszę o podanie numeru pakowacza znajdującego się na kartonie

 R - 8 St. 3 x 30 mm	 W - 4 St.	 M - 4 St. 4 x 25 mm	 O - 1 St.
 N - 4 St. 4 x 30 mm	 U - 2 St.	 H - 2 St.	 F - 4 St.
 E - 50 St.	 C - 3 St.	 G - 16 St. 3,5 x 16 mm	 L - 20 St.
 A - 4 St.	 B - 24 St.	 D - 3 St.	 S - 1 St.
 T - 1 Kpl.	 K - 20 St.	 Z - 1 St.	 J - 4 St. 5 x 13 mm

I

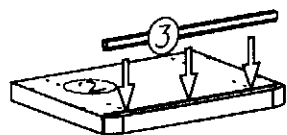
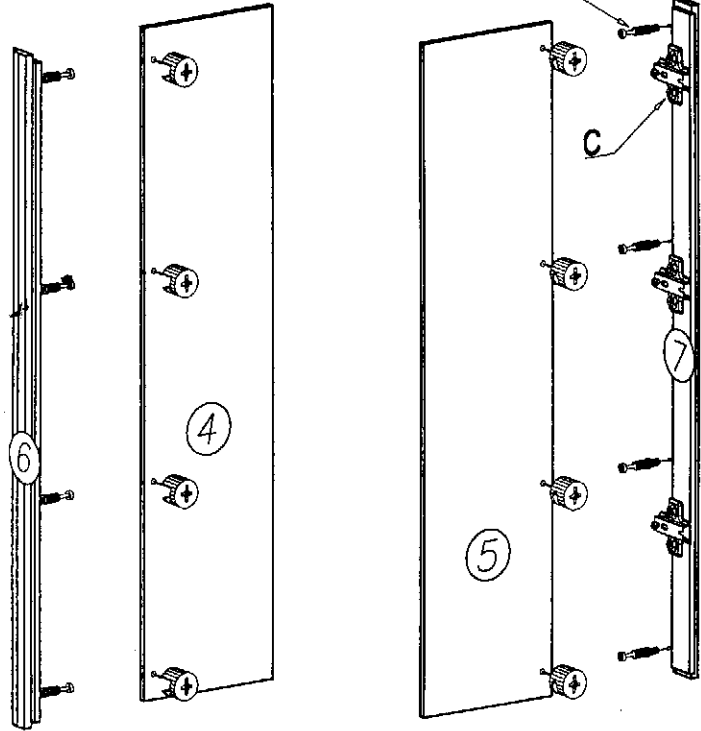
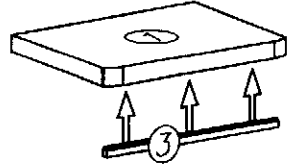

II

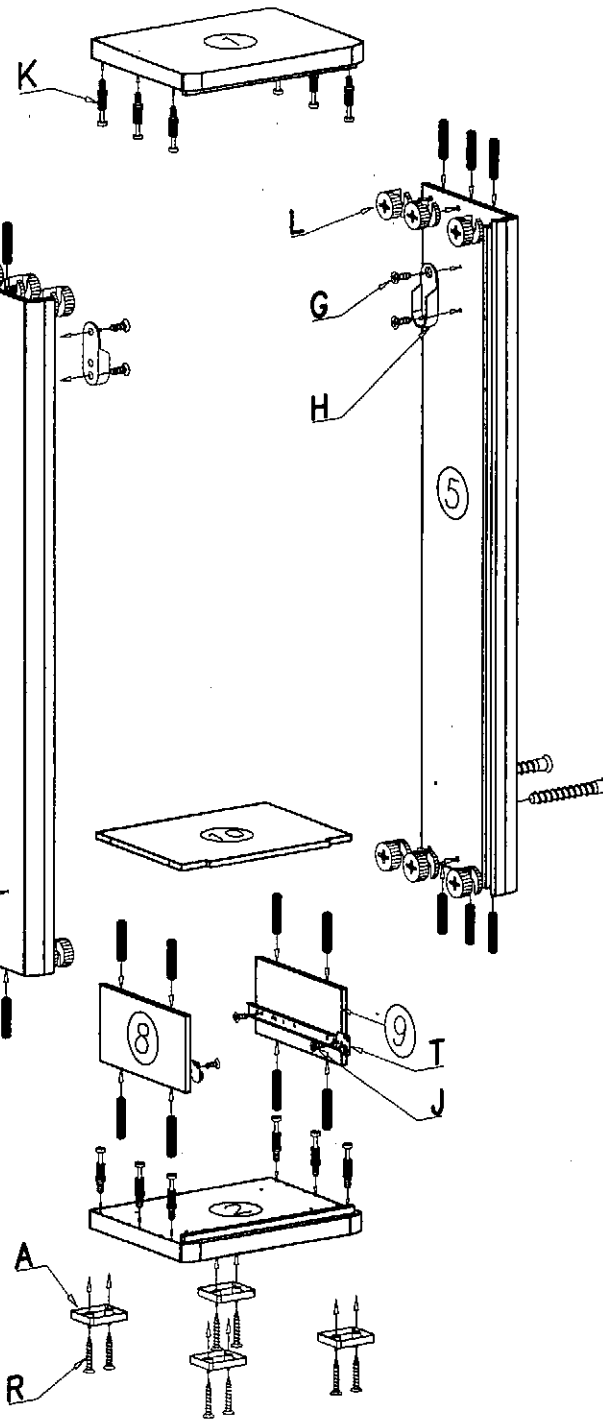

III

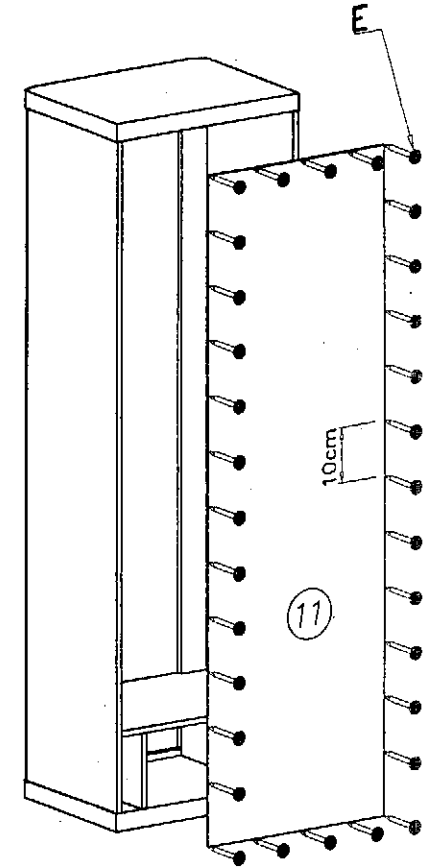

IV prawa

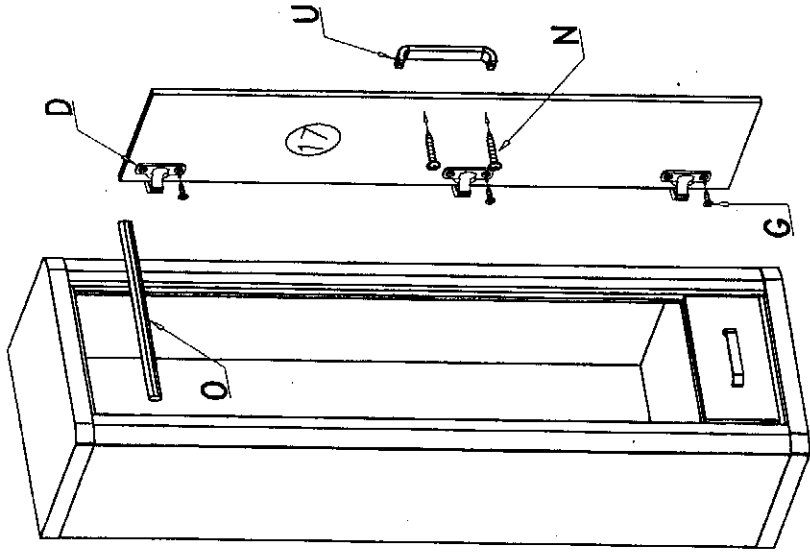

IV lewa

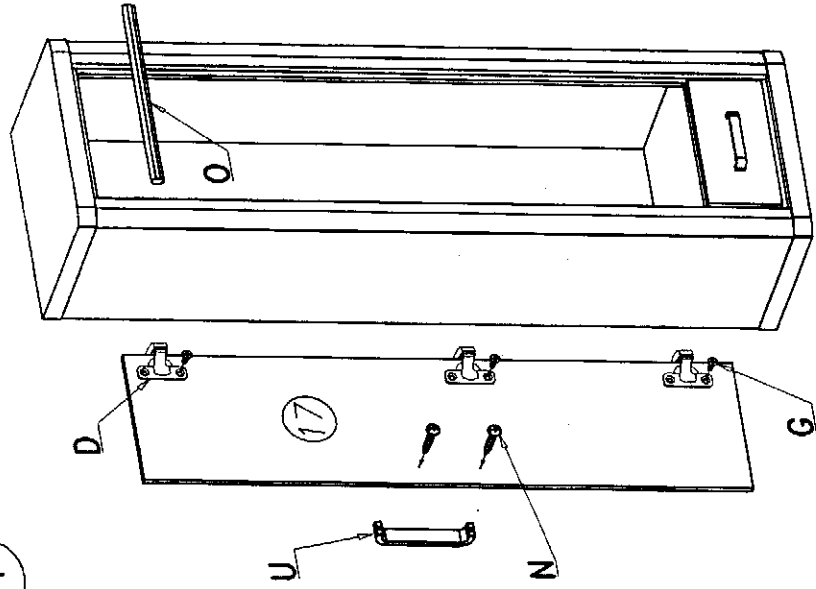

V

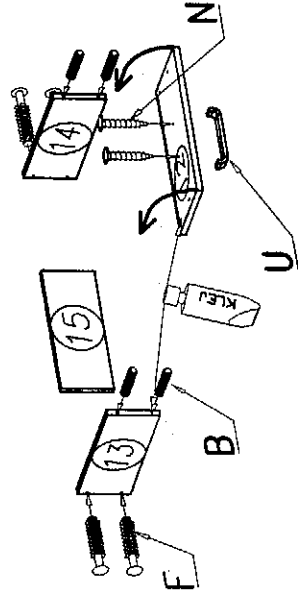

VI opcja

