

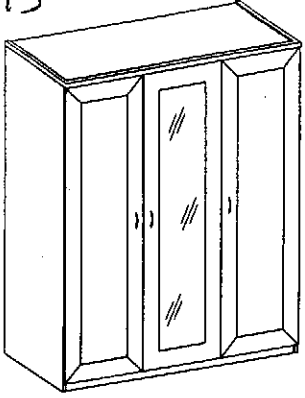















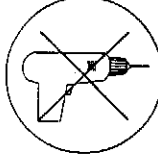
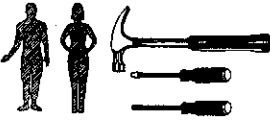
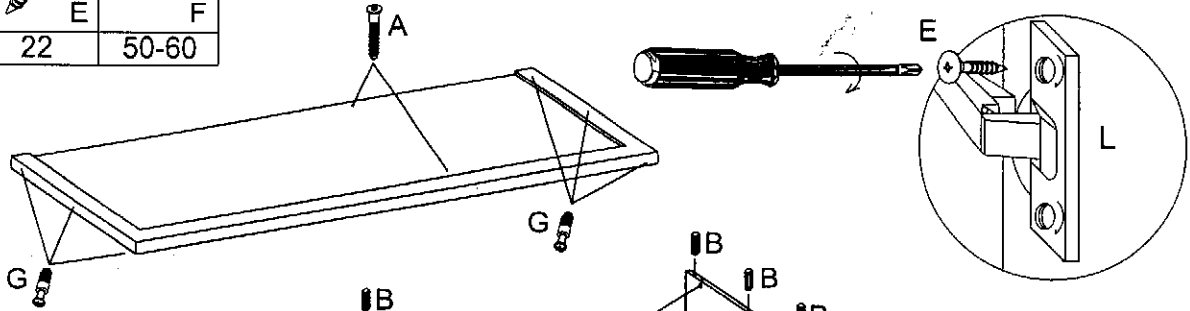

T15



 A	 B	 C	 D	 E	 F
8	16	3	6	22	50-60
 G	 H	 I			
6	6	6			



 J	 K	 L
4	16	9
 M	 N	 R
9	1	8
 S	 T	
2	1	

