

system VEGAS

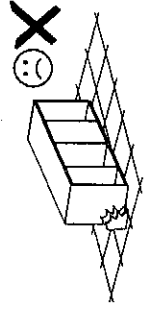

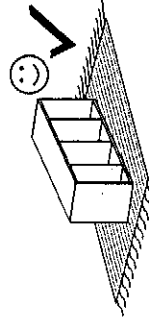

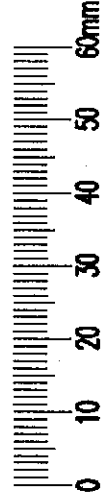
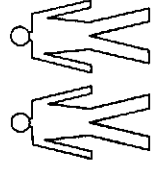
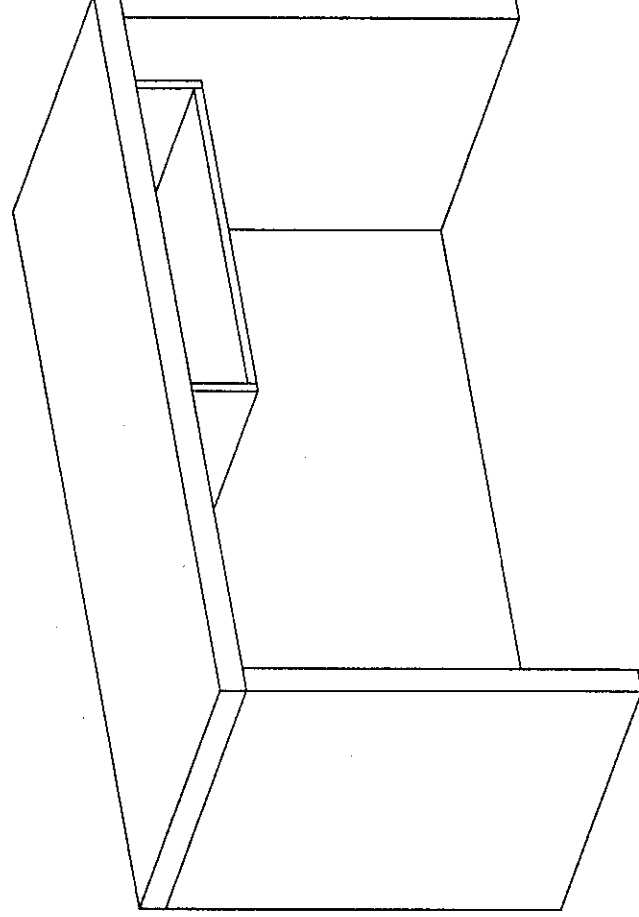
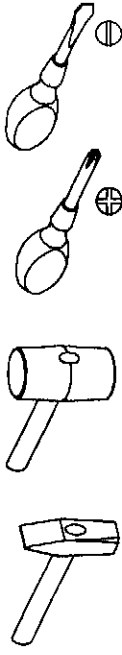

V-30

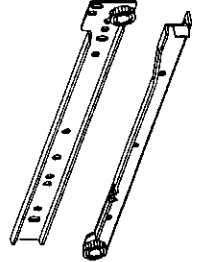

Narzędzia potrzebne do montażu

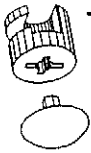

W przypadku reklamacji proszę o podanie numeru pakowacza znajdującego się na kartonie

 <p>G - 4 St. 3 x 16 mm</p>	 <p>T - 1 Kpl.</p>	 <p>W - 2 St.</p>  <p>K - 19 St.</p>	 <p>B - 14 St.</p>  <p>Z - 1 St.</p>	 <p>L - 19 St.</p>  <p>J - 4 St. 5 x 13 mm</p>
---	---	--	--	--

I

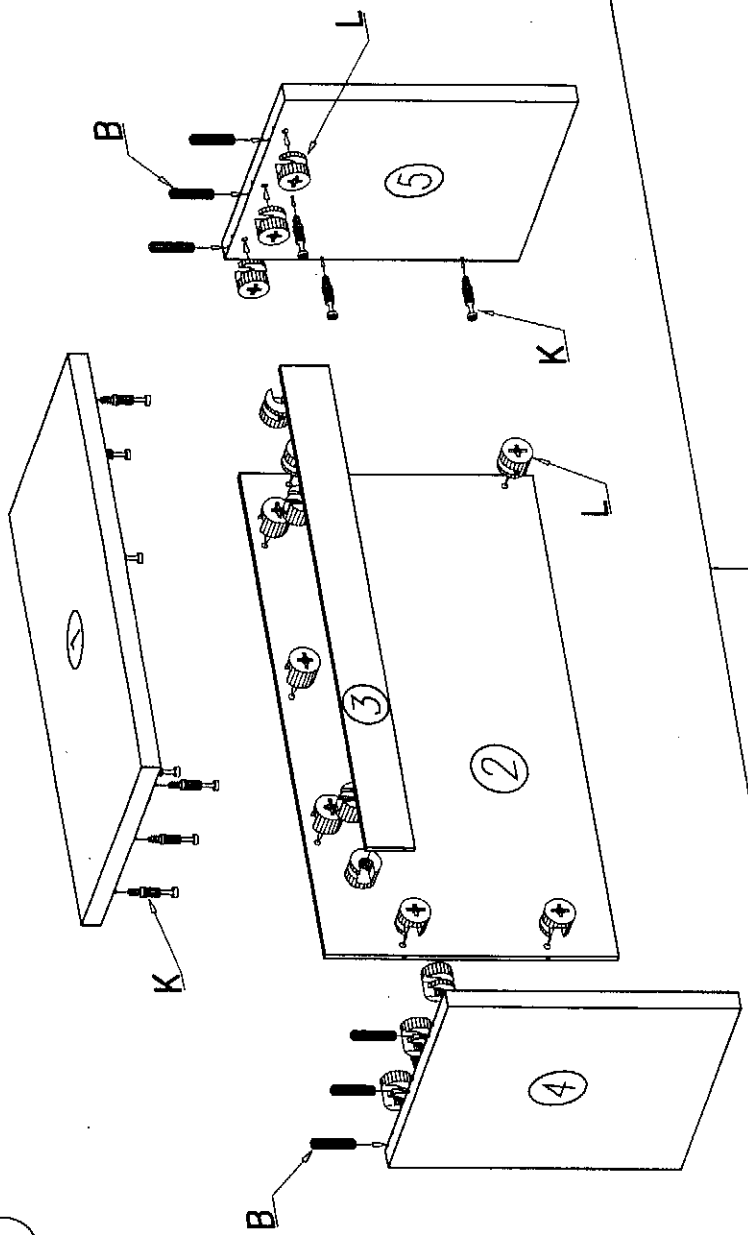

II

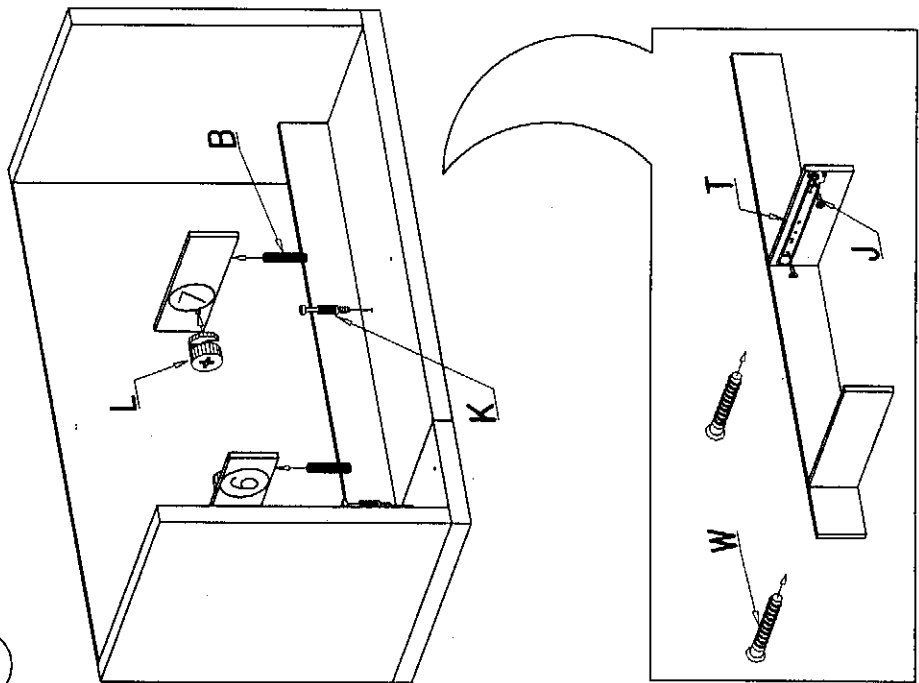

III

