

system VEGAS

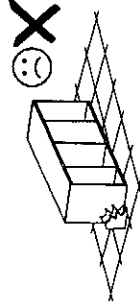

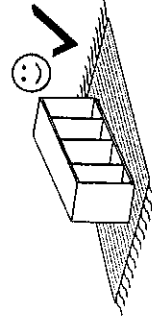

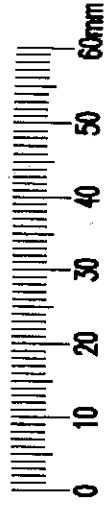

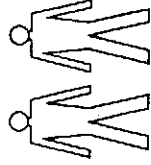
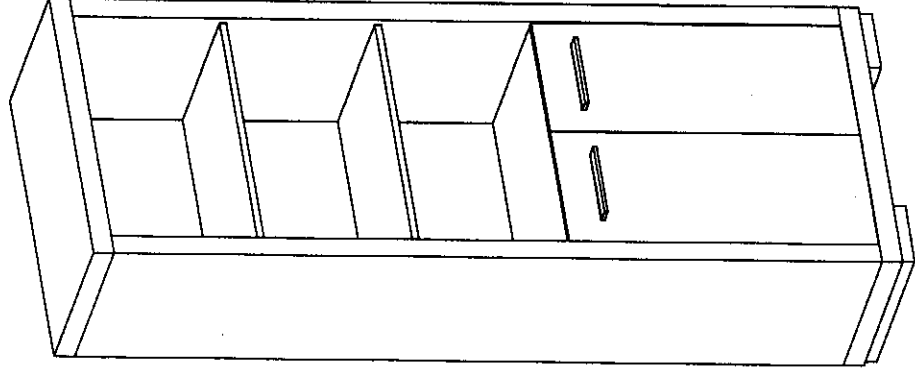
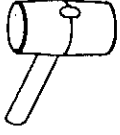



V-34

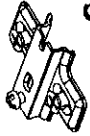

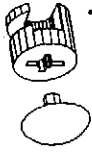
Narzędzia potrzebne do montażu

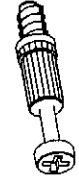
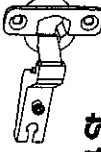

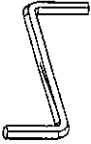
W przypadku reklamacji proszę o podanie numeru pakowacza znajdującego się na kartonie

 N - 4 St. 4 x 30 mm	 U - 2 St.	 C - 4 St.	 P - 12 St.	 L - 12 St.
 E - 50 St.	 B - 12 St.	 K - 12 St.	 D - 4 St.	 G - 8 St. 3,5 x 16 mm
		 Z - 1 St.	 H - 1 St.	

II

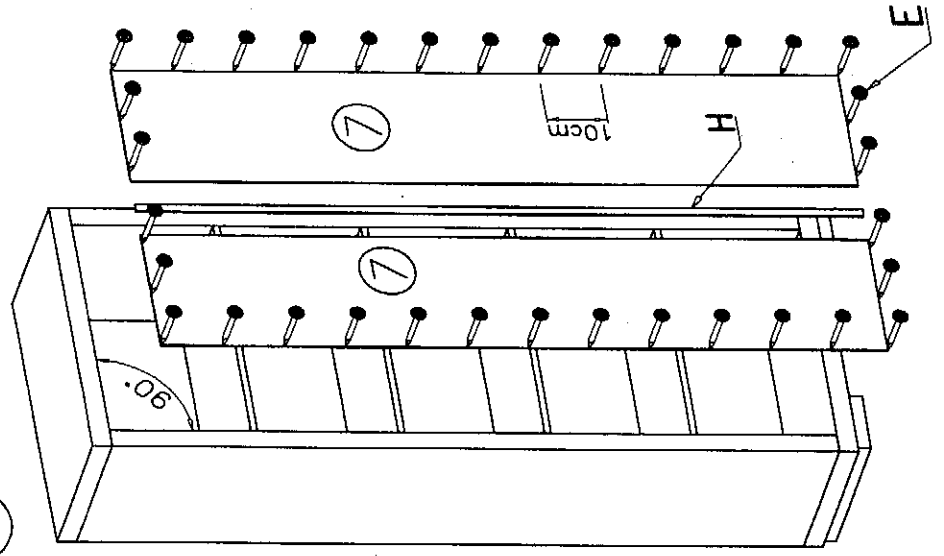

I

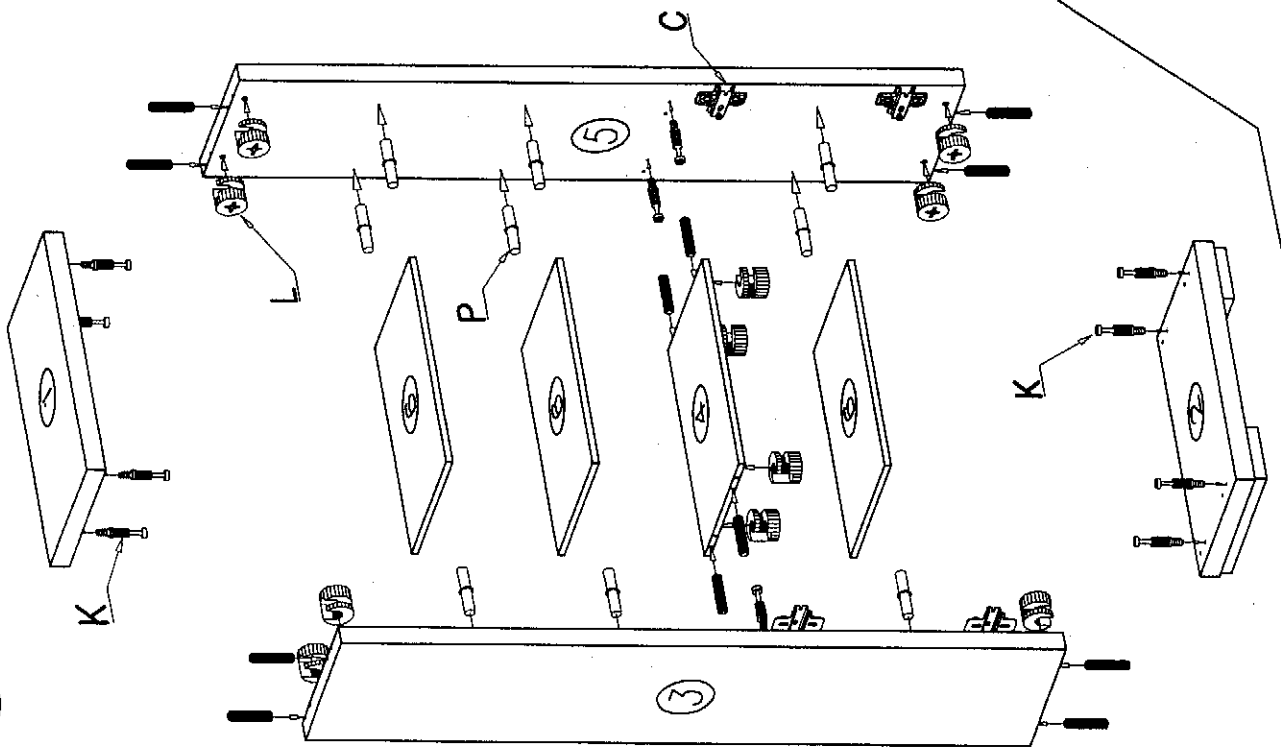

III

