

# system VEGAS

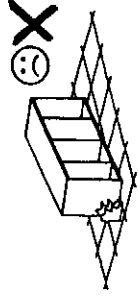

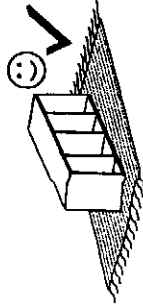

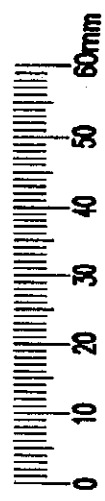

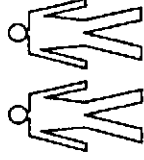
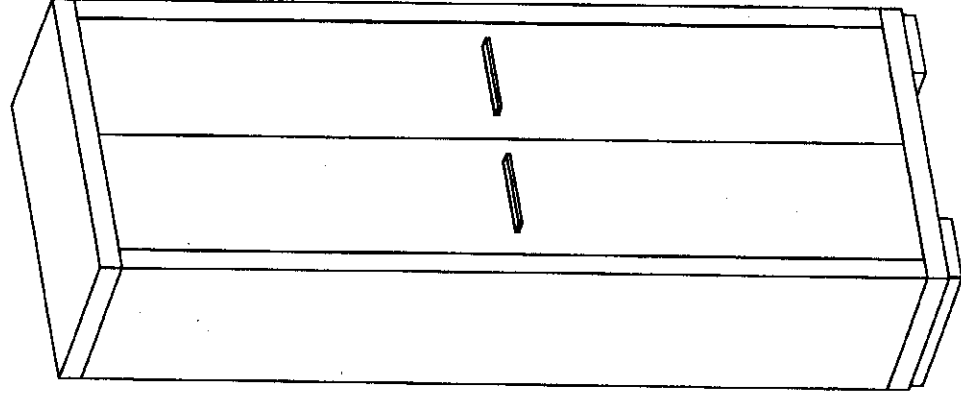
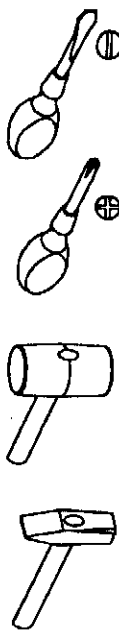





V-35



Narzędzia potrzebne do montażu



W przypadku reklamacji proszę o podanie numeru pakowacza znajdującego się na kartonie

 <p><b>N - 4 St.</b> 4 x 30 mm</p>	 <p><b>U - 2 St.</b></p>	 <p><b>C - 6 St.</b></p>	 <p><b>P - 12 St.</b></p>	 <p><b>L - 12 St.</b></p>
 <p><b>E - 50 St.</b></p>	 <p><b>B - 12 St.</b></p>	 <p><b>K - 12 St.</b></p>	 <p><b>D - 6 St.</b></p>	 <p><b>G - 16 St.</b> 3,5 x 16 mm</p>
			 <p><b>Z - 1 St.</b></p>	 <p><b>H - 1 St.</b></p>

1

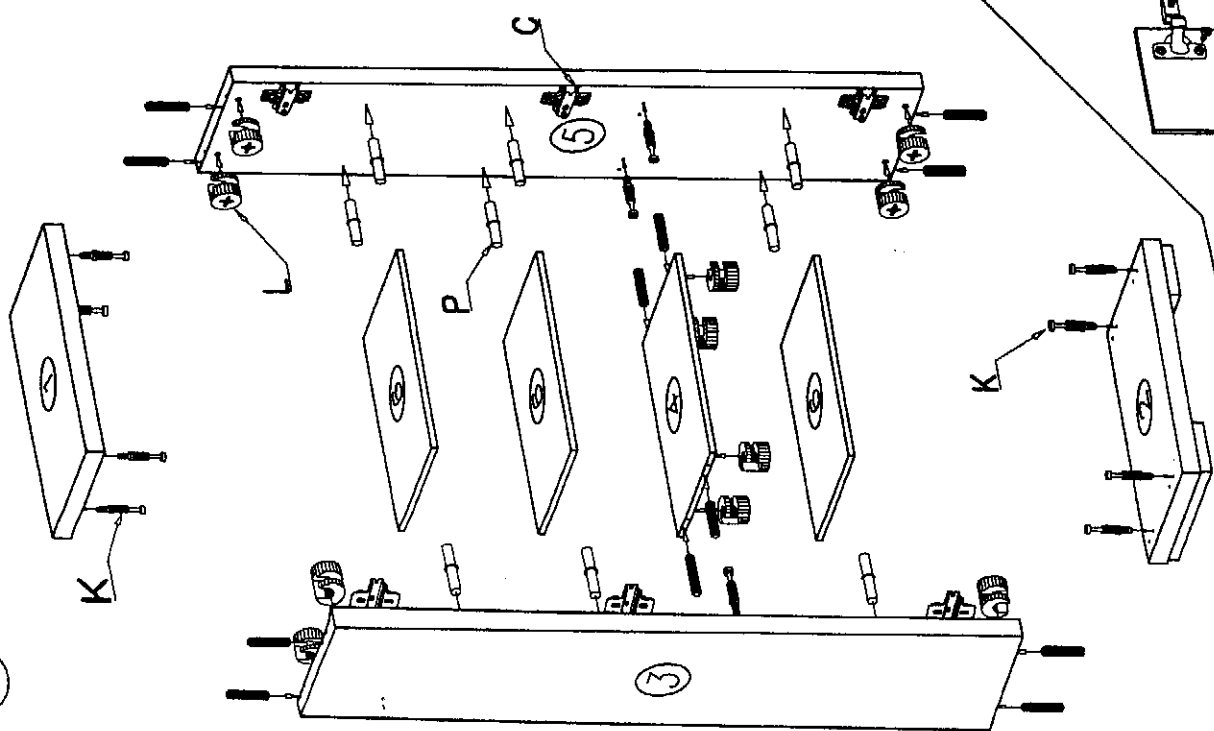

II

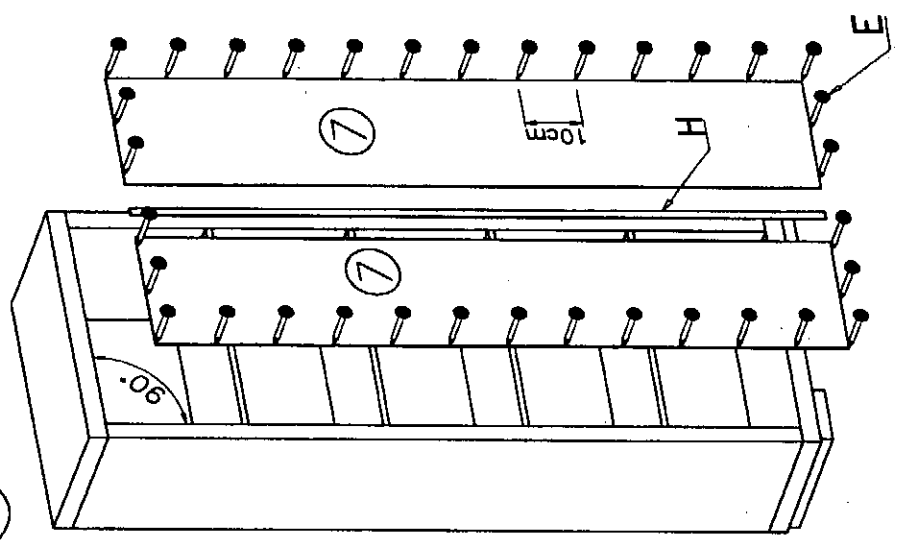

III

